

Article number: 2030100M1080A2S

Description: E+G levelling foot  
GN 30-100-M10-80-A2-S

Note: S Withoutnut, External hexagon at the bottom

## Measures

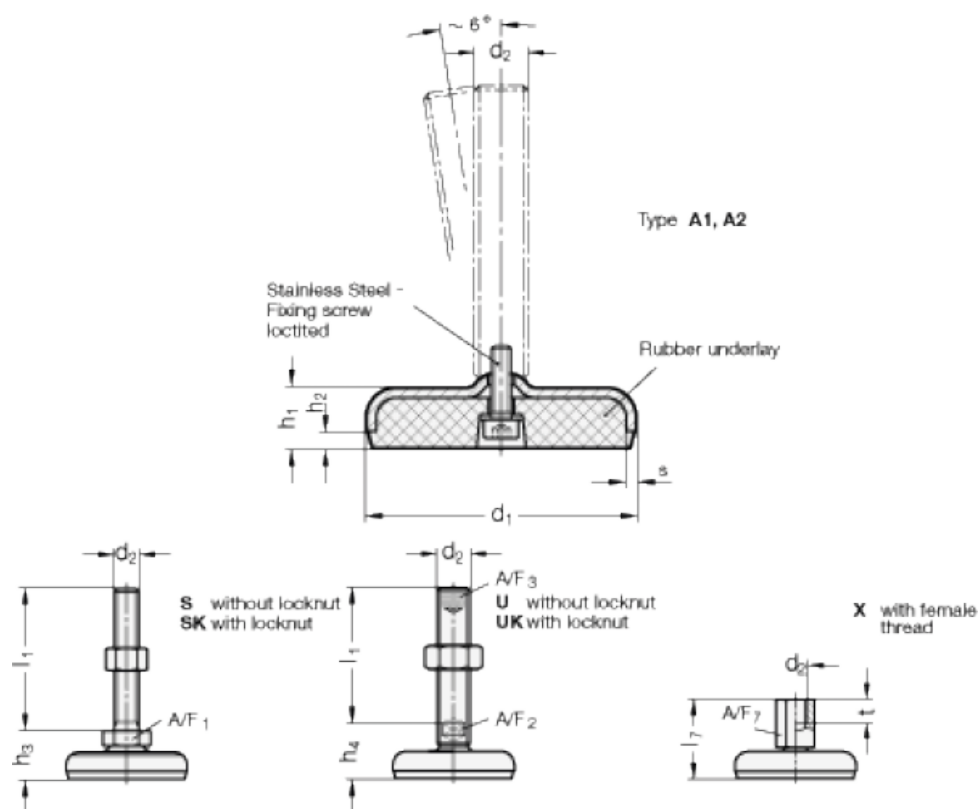

A/F1	=	17
d1	=	100
d2	=	M10
h1	=	20
h2	=	6
h3	=	28
l1	=	80
s	=	3